

DAVEY WATER PRODUCTS GUARANTEE FOR AUSTRALIA & NEW ZEALAND

Davey Speedman Compact is guaranteed for a period of two years from the date of original purchase to be free of material or manufacturing defects. Should any part fail as a result of such defects within this period, the pressure system will be repaired free of charge.

TERMS AND CONDITIONS

1. This guarantee applies to all states and territories of Australia and New Zealand only and is subject to the provisions of the Trade Practices Act (Aust.), the Goods and Consumer Protection Legislation of the various Australian states and the Consumers Guarantee Act 1993 (NZ) as applicable.
2. The guarantee period commences on the date of original purchase of the equipment. Evidence of this date of original purchase must be provided when claiming repairs under guarantee. It is recommended you retain all receipts in a safe place.
3. This guarantee covers parts and workshop labour only. Goods should be forwarded, with proof of date of original purchase, to an Authorised Davey Service Centre freight paid.
4. This guarantee is subject to due compliance by the original purchaser with all directions and conditions set out in the Installation and Operating Instructions. Failure to comply with these instructions, damage or breakdown caused by fair wear and tear, negligence, misuse, incorrect installation, chemical or additives in the water, inadequate protection against freezing, rain or other adverse weather conditions, corrosive or abrasive water, lightning or high voltage spikes or through unauthorised persons attempting repairs are not covered under guarantee. The product must only be connected to the voltage shown on the nameplate.
5. Without limiting the original purchaser's entitlements under the Trade Practices Act (Aust.), the Goods & Consumer Protection Legislation of the various Australian states, or the Consumers Guarantee Act 1993 (NZ), Davey shall not be liable for any loss of profits or any consequential, indirect or special loss, damage or injury of any kind whatsoever arising directly or indirectly from the product or any defect.
6. Where the Trade Practices Act (Aust.), the Goods and Consumer Protection Legislation of the various Australian states and the Consumers Guarantee Act 1993 (NZ) does not apply, Davey shall not be liable for any loss of profits or any consequential, indirect or special loss, damage or injury of any kind whatsoever suffered by the purchaser arising directly or indirectly from the product or any defect and the purchaser shall indemnify Davey against any claim by any other person whatsoever in respect of any such loss, damage or injury.
7. Nothing in this guarantee is intended to have the effect of contracting out of the provisions of the Trade Practices Act (Aust.), the Goods and Consumer Protection Legislation of the various Australian states and Consumers Guarantee Act 1993 (NZ) except to the extent permitted by the various Acts and this guarantee is to be modified to the extent necessary to give effect to that intention.
8. Davey may be collecting personal information from you in order to provide you with a service. Davey Pumps Pty Ltd promises only to use this information in accordance with the Provisions of the Privacy Act 1988 (Cth) and the Privacy Policy of Davey Pumps Pty Ltd which is available at davey.com.au.

© Davey and Speedman are registered trademarks of Davey Water Products Pty Ltd. © Davey Water Products Pty Ltd 2009.

Davey Water Products Pty Ltd

Member of the GUD Group
ABN 18 066 327 517

Head Office and Manufacturing

6 Lakeview Drive,
Scoresby, Australia 3179
Ph: +61 3 9730 9222
Fax: +61 3 9753 4100
Website: davey.com.au

Customer Service Centre

Ph: 1300 2 DAVEY (1300 232 839)
Fax: 1300 304 850
E-mail: sales@davey.com.au

Interstate Offices

Sydney • Brisbane • Adelaide
Perth • Townsville

International

6 Lakeview Drive,
Scoresby, Australia 3179
Ph: +61 3 9730 9121
Fax: +61 3 9753 4248
E-mail: export@davey.com.au

USA

Website: daveyusa.com
E-mail: sales@daveyusa.com

Davey Water Products

– New Zealand

7 Rockridge Avenue,
Penrose, Auckland 1061
Ph: +64 9 570 9135
Fax: +64 9 527 7654
Website: daveynz.co.nz
E-mail: sales@daveynz.co.nz

Davey Spa – New Zealand

2 Rothwell Avenue,
North Harbour, Auckland 0632
Ph: +64 9 415 8622
Fax: +64 9 415 8621
Website: spa-quip.co.nz
E-mail: service@spa-quip.co.nz

DEPEND ON
DAVEY

WATER PRODUCTS

Installation and Operating Instructions for Davey Speedman Compact Constant Water Pressure Systems

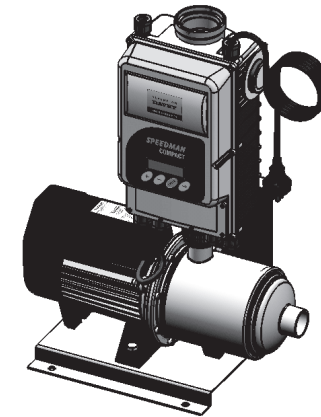

NOTE: Prior to installation remove the inlet and outlet pipe transport plugs & associated seals from the suction and/or discharge ports.



WARNING : The Speedman Compact system and associated pipework operate under pressure. Under no circumstances should the Speedman Compact System or associated pipework be disassembled unless the internal pressure of the unit has been relieved. Failure to observe this warning will expose persons to the possibility of personal injury and may also result in damage to the pump, pipework or other property.



WARNING: Failure to follow these instructions and comply with all applicable codes may cause serious bodily injury and/or property damage.

Please pass these instructions on to the operator of this equipment.

Prior to using this pump you must ensure that:

- The pump is installed in a safe and dry environment
- The pump enclosure has adequate drainage in the event of leakage
- Any transport plugs are removed
- The pipe-work is correctly sealed and supported
- The pump is primed correctly
- The power supply is correctly connected
- All steps have been taken for safe operation

Appropriate details for all of these items are contained in the following Installation and Operating Instructions. Read these in their entirety before switching on this pump. If you are uncertain as to any of these Installation and Operating Instructions please contact your Davey dealer or the appropriate Davey office as listed on the back of this document.

Congratulations on your purchase of a high quality, Davey constant pressure water pressure system. All components have been designed and manufactured to give trouble free, reliable operation.

Your new pressure system incorporates the Speedman Compact, electronic flow controller – a unit that enables the use of a highly efficient pump design and offers the following benefits:–

1. Enables the pump to deliver a constant pressure of water particularly across a wide range of flow rates – reducing the inconvenience of pressure variation in showers etc.
2. Provides automatic “cut-out” protection should the pump run out of water, should the pump fail to start due to low voltage or a blockage in the pump.
3. Provides warning indications for system faults.
4. Has adjustable pressure setting to allow for various operating conditions.
5. Automatic retry functions in the event of a variety of system faults.
6. Motor overload protection included.

Before installing your new pump system, please read all instructions carefully as failures caused by incorrect installation or operation are not covered by the guarantee. Your Davey pressure system is designed to handle clean water. The system should not be used for any other purpose without specific referral to Davey. The use of the system to pump flammable, corrosive and other materials of a hazardous nature is specifically excluded.

NOTE: Prior to installation remove the inlet and outlet pipe transport plugs from the suction and/or discharge.



NOTE: For protection, the Davey® pump controller monitors input current and will shut down the pump motor in the event of an over load.



WARNING: When servicing or attending pump, always ensure power is switched off and lead unplugged. Electrical connections should be serviced only by qualified persons. If the electrical supply lead of this pressure system is damaged, it must be replaced.



Care should also be taken when servicing or disassembling pump to avoid possible injury from pressurised water. Unplug pump, relieve pressure by opening a tap on the discharge side of the pump and allow any hot water in the pump to cool before attempting to dismantle.



During servicing, use only approved, non-petrochemical based oring and gasket lubrication. If unsure, consult your Davey Dealer for advice.



WARNING: Do not use hydrocarbon based or hydrocarbon propelled sprays around the electrical components of this pump.

After Sales Service

For professional after sales service or repair contact your Davey Dealer. For assistance in locating your nearest dealer contact the Davey Customer Service Centre on 1300 367 866 or the appropriate branch as listed on the back of this document.



Visit Davey Water Products on-line for further information
davey.com.au

MESSAGE	MESSAGE MEANING	PUMP STATE	WHAT TO DO
Imax fault	• An excessive amount of electrical current is registered in the pump	Off	<ul style="list-style-type: none"> • Verify that the pump is used in conditions suggested by the manufacturer • Make sure that there are no points of friction or blocking with regard to the rotor • Do the setting sequence to set the MaxCurr parameter

Maintenance Menu and Extended Menu

During normal operation the Maintenance Menu is available. It displays some parameters regarding the functioning of the controller. The Extended Menu is only available via password.

Note: We strongly advise you *NOT* to alter settings for these menus. These menus are intended for trained service persons only.

Maintenance



WARNING : Under no circumstances should the Speedman Compact controller be disassembled by other than qualified tradespersons. Failure to observe this warning may expose persons to the possibility of personal injury and may also result in damage to other property. Do not dismantle spring under pressure.

The only regular attention your new pressure system may require will be if you have used an additional pressure tank. You will need to check the pressure tank's air charge every 6 months. This can be checked at the air valve with a tyre gauge. Do not charge tank to a higher pressure than that shown in the table on page 6.

To check air pressure in tank:

1. Switch off pump.
2. Open outlet nearest to pump to release water pressure.
3. Charge tank to required pressure using air pump and check with tyre gauge.
4. Switch on.
5. Close outlet.



WARNING: Automatic resets may allow the pump to restart without warning. Always disconnect the pump motor from the electrical supply before maintenance or repairs.



WARNING: When servicing or attending pump and/or controllers, always ensure power is switched off and lead unplugged. Electrical connections should be serviced only by qualified persons.

Technical Features and Usage Conditions

- Operational temperature: 0°C to +40°C
- Maximum humidity: 50% at +40°C (no condensate)
- Temperature of fluid: +1°C to +40°C
- Nature of fluid: water with no chemical additives (ph 5 to 9)
- Power Supply: Single phase: 230 Vac 50Hz*
- Set point pressure: preset at 2.5 bar (250kPa) and adjustable between 1.0 to 7.5 Bar (100 to 750kPa), ± 0.2 Bar
- Overpressure Maximum: 12 Bar
- Electric safety and electromagnetic compatibility: EN60730, EN61000-6-3, EN61000-6-4

*For 60Hz operation consult your Davey Water Products dealer for advice.

1. Pump Priming Plug
2. Speedman Compact Control Module
3. Discharge Outlet (1/4" BSPF)
4. Suction Inlet (1/4" BSPF)
5. Pump Body
6. Motor
7. Rotary Coupling
8. Motor Mounting Bolts
9. Controller Mounting Screws
10. Support Bracket Capscrews

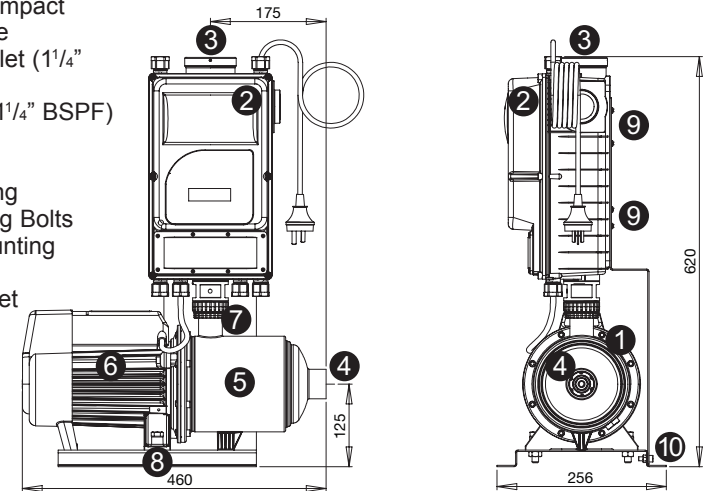

All measurements in mm.

Preparing Your System

On removing your Speedman Compact system from the carton check that the standard orientation of the pump inlet and controller is suitable. If required, the inlet can be re-orientated 180 degrees.

To rotate the pump inlet to the alternate position, prior to installation, undo the two motor mounting bolts (8), the four controller mounting screws (9) and the two support bracket capscrews (10). The pump can then be rotated relative to the controller by loosening the rotary coupling slightly (7). Re-position the support bracket to the holes on the opposite end of the mounting base and re-affix with the support bracket capscrews. Re-position the pump and controller on the base, tightening all items (7, 8, 9 and 10) carefully.



Only connect the discharge pipework to the discharge port. The priming port is not a discharge port.

Choosing a Site

Choose a site with a firm base and as close to the water source as possible with correct power supply. Make sure your pressure system is always connected to an adequate, reliable source of clean water.

Housing your Davey Pressure System

To protect your pressure system from the weather, make sure the pump house is both water proof, frost free and has adequate ventilation. The pump should be horizontally mounted on a firm base allowing for drainage, to avoid damage to flooring etc., that over time may occur from leaking pipe joints or pump seals. Do not mount the pump vertically.

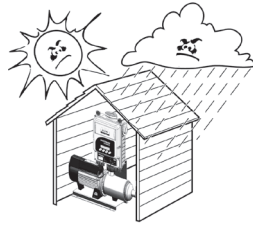

WARNING: Some insects, such as small ants, find electrical devices attractive for various reasons. If your pump enclosure is susceptible to insect infestation you should implement a suitable pest control plan.

Power Connection

Connect lead to power supply (220-240V 1phase 50Hz) as designated on controller label. Note that while the pump motor is rated three phase, the single phase supply is inverted to suit in the controller. Do not use long extension leads as they cause substantial voltage drop, poor pump performance and may cause motor overload.



The Davey Speedman Compact fitted to this pump has a **status indicator** mounted on its front panel. This will be illuminated whenever the Speedman Compact senses that there is electrical power available. It will only work when unit is connected to the correct electrical supply.



The electrical connections and checks must be made by a qualified electrician and comply with applicable local standards.

Electrical Power Surge Protection

An electrical power surge or spike can travel on the supply lines and cause serious damage to your electrical equipment. The Speedman Compact controller fitted to this system has a metal oxide varistor (MOV) fitted to help protect it's circuit. This MOV is a "sacrificial" device, meaning that it effectively is gradually damaged every time it takes a surge. The MOV is not a lightning arrestor and may not protect the control unit if lightning or a very powerful surge hits the pump unit.

If the installation is subject to electrical power surges or lightning we strongly recommend the use of suitable additional surge protection devices on ALL electrical equipment.

MESSAGE	MESSAGE MEANING	PUMP STATE	WHAT TO DO
..STOP CC.....	<ul style="list-style-type: none"> After 10 reset attempts for short circuit ph-ph-gnd of the electropump 	Off	<ul style="list-style-type: none"> For reset is necessary to contact Davey technical support
High temperature	<ul style="list-style-type: none"> Water temperature above 75°C Automatic reset when the temperature falls to under 60°C 	Off	<ul style="list-style-type: none"> Check that the incoming water temperature is within the product specifications Check and restore the correct pump priming condition
Press.Insuff.....	<ul style="list-style-type: none"> High flow and very low pressure Automatic reset (Set at the factory for 1 resetting attempt every 5 minutes if unsuccessful the reset operation will be attempted every 50 minutes for 24 times. After which the system will remain in permanently blocked state) 	Off	<ul style="list-style-type: none"> Eliminate the high flow, usually a broken pipe Restore correct pump priming condition Check that any inline filters are not clogged Reset: <ol style="list-style-type: none"> 1 Disconnect the power supply 2 Wait for the display to switch off 3 Restore the power supply
No water.....	<ul style="list-style-type: none"> Lack of water found Electro-pump off Automatic and programmable reset (Set at the factory for 5 resetting attempt every 5 minutes if unsuccessful the reset operation will be attempted every 50 minutes for 24 times. After which the system will remain in permanently blocked state) 	Off	<ul style="list-style-type: none"> Check that the water is present in the supply Restore correct pump priming condition Check that any inline filters are not clogged Reset: <ol style="list-style-type: none"> 1 Disconnect the power supply 2 Wait for the display to switch off 3 Restore the power supply
ProSensor Fault.	<ul style="list-style-type: none"> A pressure sensor fault has been found 	Off	<ul style="list-style-type: none"> Consult the assistance service

...continued overleaf.

Self Diagnostics Display

Should the Speedman Compact controller shut down unexpectedly, check the controller screen for fault diagnostics information. The display will also provide status information during normal operation.

MESSAGE	MESSAGE MEANING	PUMP STATE	WHAT TO DO
Disabled.....	<ul style="list-style-type: none"> Controller engaged but not engaged for electro-pump checking 	Off	<ul style="list-style-type: none"> Repeat the start-up procedure, setting ON/OFF = 1
Active.....	<ul style="list-style-type: none"> Controller is checking the pressure Pressurised system 	Off	
Active..1.0.0...	<ul style="list-style-type: none"> Controller is checking the pressure Pressurised system 	On	
Active (leakage)	<ul style="list-style-type: none"> Controller is checking the pressure The system is leaking 	Off	<ul style="list-style-type: none"> Attempt to eliminate the cause of the faulty sealing of the plumbing system
Low ACMain.....	<ul style="list-style-type: none"> The power supply voltage is too low (under 170 Vac) Automatic reset 	Off	<ul style="list-style-type: none"> Check the electrical system and reset the values to the range as envisaged for the controller
High ACMain.....	<ul style="list-style-type: none"> The power supply voltage is too high (above 270 Vac) Automatic reset 	Off	<ul style="list-style-type: none"> Check the electrical system and reset the values to the range as envisaged for the controller Check if there is air in pump and eliminate it
Short ph-ph-gnd.	<ul style="list-style-type: none"> A phase/phase short circuit or a phase/earth short circuit has been found on the pump motor Automatic and programmable reset Set at the factory for 5 attempts at resetting every 10 sec; if unsuccessful, the system will remain in a permanently locked state 	Off	<ul style="list-style-type: none"> Eliminate the short-circuit Check the correct motor insulation <p>Reset:</p> <ol style="list-style-type: none"> 1 Disconnect the power supply 2 Wait for the display to switch off 3 Restore the power supply

In accordance with AS 3350.2.41 we are obliged to inform you that this appliance is not intended for use by young children or infirm persons unless they have been adequately supervised by a responsible person to ensure that they can use the appliance safely. Young children should be supervised to ensure that they do not play with the appliance.



NOTE: For protection, the Davey Speedman Compact controller is equipped with an automatic reset current sensing overload, constant tripping of this overload indicates a problem e.g. low voltage at pump, excessive temperature (above 50°C) in pump enclosure.

Pipe Connections

For best performance use P.V.C. or polythene pipes at least the same diameter as the pump's inlet and delivery outlet openings. Larger diameter pipe may be used to minimise resistance to flow when pumping longer distances.



Do not use pipe thread sealing compounds on any part of this pump. ONLY use Teflon sealing tape.



Use unions at pipe connections to enable easy removal and servicing. Use sufficient tape to ensure airtight seal and hand tighten only. To prevent strain on pump threads always support heavy inlet and outlet pipes. If there is a likelihood the water supply may contain solid particles such as pieces of plant or vegetable matter, a filter should be installed before the pump to avoid blocking of water ways. Lay suction pipe at a constant gradient to avoid air pockets which may reduce pump efficiency.



NOTE: Suction leaks are the largest cause of poor pump performance and are difficult to detect. Ensure all connections are completely sealed using thread tape only.

Extra Draw-off Capacity

The Speedman Compact has an in-built accumulator which will accommodate small leaks. In some applications it may be appropriate to install additional accumulator (Supercell pressure tank) capacity. These applications includes:

- Long suction lines (see Suction Lines / Lift)
- Low flow appliances connected to the pump, such as evaporative air conditioners, slow filling toilet cisterns.

Any additional accumulators can be installed downstream of the controller (ie. between the controller and the first outlet).

Where extra draw-off capacity is utilised the additional pressure tank should have a pre-charge 15kPa below the system pressure setting.



DO NOT USE THREAD SEALING COMPOUNDS, HEMP OR PIPE DOPE!

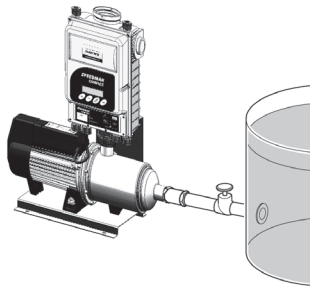

Installations with flooded suction require a gate or isolating valve so water supply can be turned off for pump removal and servicing.

! Abrasive Materials
The pumping of abrasive materials will cause damage to the pressure system which will then not be covered by the guarantee.

For Automatic Pressure Pumps Installed with a Mains Pressure Hot Water System

To protect your system from damage caused by back pressure from hot water systems. You should always have installed on the hot water inlet an approved non-return valve.

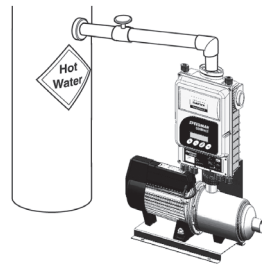

! NOTE: Always ensure hot water systems are installed in compliance with manufacturers recommendations and in accordance with all local regulations.

Connection of Mains Scheme or Town Water Supply to either Suction or Discharge of Pumps & Pressure Systems

Most Water Supply Authorities have strict regulations regarding direct connection of pumps to mains water supplies. In most cases an isolating tank is required between mains supply and pump. Davey also recommend this method. Directly applied mains pressure can exceed pump operating pressure and damage pump.

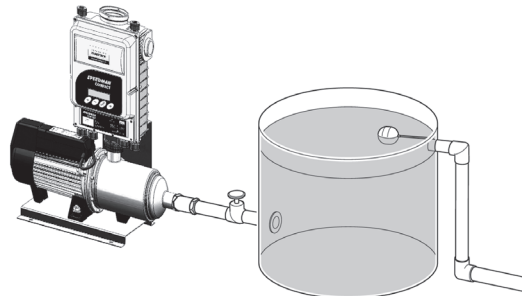

Davey Water Products Pty Ltd can not accept responsibility for loss or damage resulting from incorrect or unauthorised installations.

Protection

Should the Speedman Compact controller detect a system fault it protects the pump by turning it off. Under some of these circumstances, it does though perform an automatic restart or reset sequence as listed below.

PROTECTION	RESET
Low AC mains	Automatic
High AC mains	Automatic
Ground-to-phase & Phase-to-phase short circuit	Number of attempts programmable (default 10). After this, attempts reset if possible only contacting our technical support.
Output current over threshold for more than 1 second (threshold MT 12A rms – MM 17A rms)	Manual restart*
Water temperature over 75°C	Automatic
Insufficient system pressure	Number of attempts programmable** (default once after 5 minutes then every 50 minutes for 24 times)
No water in pump or air in the pump	Number of attempts programmable** (default once after 5 minutes then every 50 minutes for 24 times)
Broken pressure sensor	—

*Procedure for manual reset.

1. Disconnect power supply
2. Wait for display to switch off
3. Reconnect power supply

**After this number of attempts it is necessary to do a manual reset.

- Speedman Compact controller will display the pre-set operating pressure.

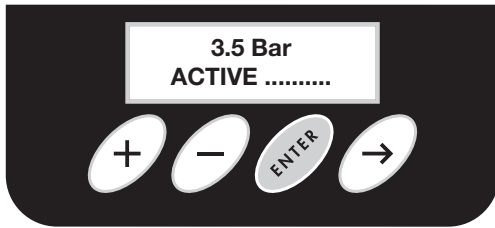

To check direction of rotation for motor

– **Note: this is factory set already.**

Check the correct sense of rotation of the pump. If you want to change:

- **Press key +** for about 5 seconds.
- With key → go to the parameter **Rotation Sense**.
- With key + and - set the value desired for rotation sense (0000 or 0001)
- Press **ENTER**, and keep pressed till it displays “Done.....”

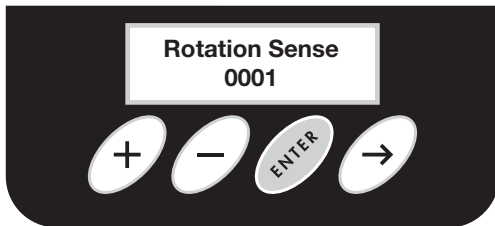

Priming and Operation

1. Remove priming plug and fill casing and suction line (on flooded suction, simply open gate valve to pump). When full, replace priming plug.

2. Ensure outlet nearest to pump is open.



3. Ensure all valves in suction line are open.

4. Switch on power - The status indicator will be illuminated and the pump will run. See section: “Start Up Procedure”. A full flow of water should be discharged from the open tap.

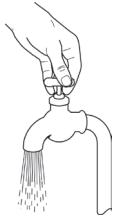

5. If the pump stops with the tap open see troubleshooting checklist.

6. Close the open outlet or tap and the pump should stop after a few seconds.

To Reset if Pump switches out in Pump Protection Mode

1. Switch off power.
2. Make sure pump is primed.
3. Open tap, switch on power.
4. Close tap and pump will stop.

Start Up Procedure

- Power the system and in 2 seconds it will display the software variant.

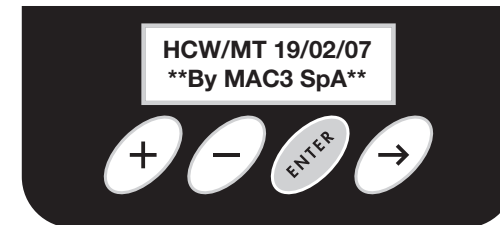

- Press **ENTER** to start system without changing any of the factory pre-sets.
- Press + only if you need to alter any of the factory pre-sets.

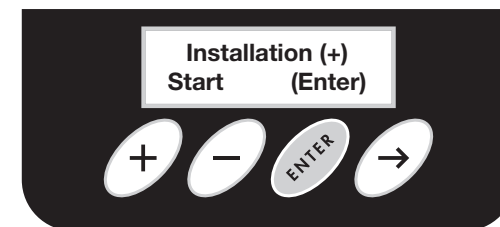

Changing Pre-sets



NOTE: The unit is factory set to suit low power use and the pump performance. It is recommended that you only adjust the "SYSTEM PRESSURE" unless advised by your Davey Water Products dealer.

The display will scroll through the various settings in order.



Language

- Press + or - to change the language.
- Pressing **ENTER**, the value is saved in memory. Keep **ENTER** pressed till it displays "Done....."

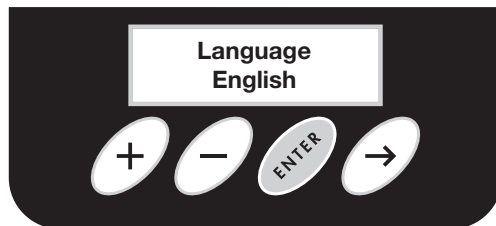

Max. Motor Current

- Press + or - to change the value.
- Insert current value as indicated on the pump motor name plate.
- Press **ENTER**, and keep pressed till it displays "Done....."

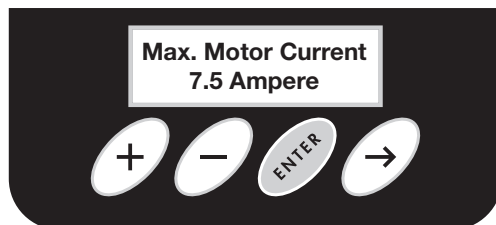

System Pressure

- Press + or - to change the value (from 1.00 to 7.50). Note: this has been factory set at 2.5 Bar.
- Insert the value for desired pressure of the system.
- Press **ENTER**, and keep pressed till it displays "Done....."

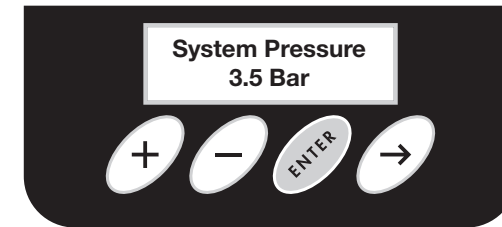

System Start

- Press + or - to change the value (ON/OFF).
ON to activate the system.
OFF not to activate the system.
- Press **ENTER**, and keep pressed till it displays "Done....."

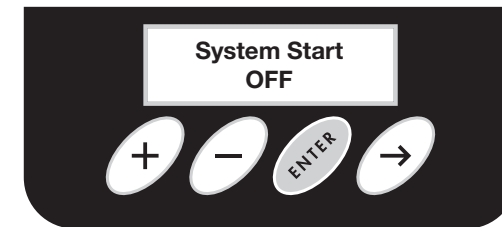

Save & Exit with ENTER

- Press **ENTER**, and keep pressed till it displays "Done....."

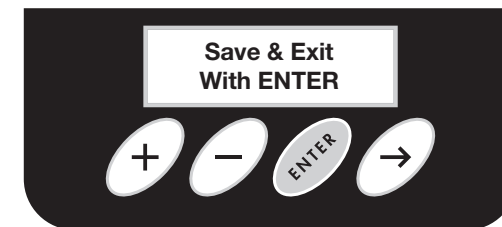

- **Saving Parameter** and **DONE** displayed. All parameters are saved in permanent memory.



Warnings: If System Start = ON, Speedman Compact controller will immediately power the pump motor!